

Riviera Classic 1 Inch Blind Model #RIV1

Top quality 1 inch horizontal aluminum window covering for commercial applications.



Key Features

DustGuard®

Headrail: 1 inch high x 1 9/16 inch wide

Nominal .008 inch slat thickness

21.5mm ladder spacing

Optional 19.5mm ladder spacing

Guardian Tilter disengaging clutch mechanism

Limited lifetime warranty

Product Overview

The Riviera Classic 1 Inch Blind represents LEVOLOR's top quality horizontal blind backed by a limited lifetime warranty. Committed to both durability and aesthetics, the Riviera Classic 1 Inch Blind combines the highest quality components with visibly attractive features to provide an overall superior product.

The DustGuard® feature is a permanent paint process that disrupts the natural static attraction of dust particles to the slat. By removing the primary reason blinds attract dust, a reduction in accumulation can be achieved. Less dust means less maintenance and a cleaner, more professional appearance.

The durable and sleek headrail is made of roll-formed corrosion-resistant painted steel. The strength of the overall headrail profile provides smooth operation, even under heavy loads associated with large window applications. The steel hardware is machine-clinched, ensuring accurate alignment of moving parts and a long, maintenance-free operation.

The nominal .008 inch thick slats are made of 5000 series magnesium aluminum alloy and provides overall strength and resiliency, guaranteeing a quality look for the life of the blind. As the industry leader, the Riviera Classic 1 Inch Blind's 21.5mm ladder spacing ensures tight closure and optimum light control. The exclusive Guardian Tilter disengaging clutch mechanism eliminates over rotation of the tilt wand and protects the tilt mechanism against breakage.

The Riviera Classic 1 Inch Blind is offered in a large selection of popular colors and specialty shapes. The SheerView perforation option provides a unique see-through feature, reducing solar heat gain by 42% as compared to a fully opened blind while optimizing the exterior view and maximizing light/glare control. Other options include the Top Lok Cord Lock, which holds the blind completely up or down for a consistent look across all windows.

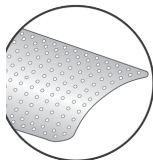
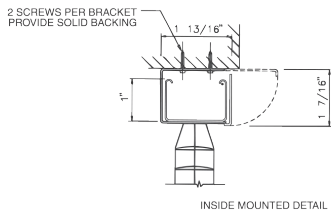
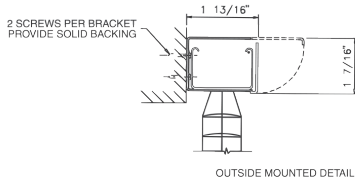
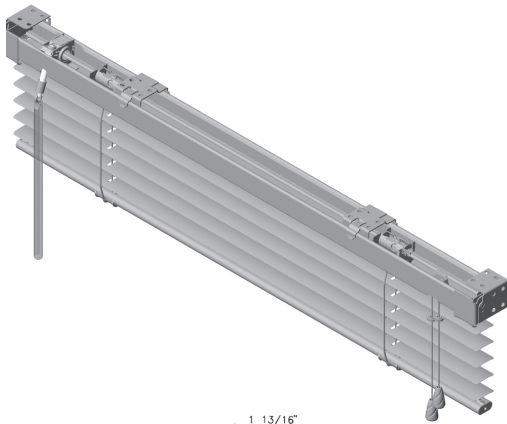

SheerView

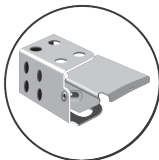

Open End Bracket



Hold-down Bracket

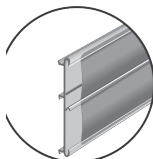

Vogue® Valance Option

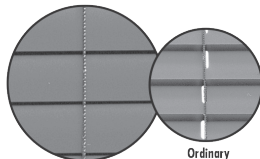

LightMaster Route Hole

Ordinary Route Hole

Product Specifications

For more detailed specifications please reference Riviera Classic 1 Inch Blind product Guide Specifications.

Products

- A. Riviera 1 Inch Blind manufactured by LEVOLOR
- B. Lifetime Limited Warranty
- C. Materials:

- Headrail** shall be of .025 inch thick painted steel, "U" shaped, 1 inch high x 1 9/16 inches wide. All hardware shall be enclosed in the steel headrail.
- Guardian Tilter** shall be of a .042 inch thick Tomized steel housing with a self-lubricating nylon, automatically disengaging worm and gear mechanism to eliminate overdrive.
- Tilt Wand** shall be transparent with a hexagonal cross section 5/16 inch across flats.
- Cord Lock** shall be .042 inch thick Tomized steel be crash-proof.
- Drum and Cradle** shall be provided for each ladder.
 - a. Drums shall be of .031 inch thick Tomized steel.
 - b. Cradles shall be of .042 inch thick Tomized steel.
- Installation Brackets** shall be of at least .048 inch thick painted steel with a rivet-hinged safety locking front cover to permit removal of headrail without lateral movement.
- Ladders** (slat supports): Distance between slats shall not exceed 21.5mm. Optional 19.5mm ladder spacing.
- Slats** shall be of 5000 series magnesium aluminum alloy. Slats shall be nominally 1 inch wide and the thickness of the slats shall be nominally .008 inches. Slats shall be (select one):
 - a. Unperforated
 - b. SheerView – Slats shall be perforated with a staggered pattern of .020 inch diameter holes, nominally 177 per inch of slat length. Slats shall have an openness factor of 6%. Available on select colors. Not all available with LightMaster™ option.
- Bottomrail** shall be of .023 inch thick painted steel.
- Options** shall include:
 - a. Cutouts
 - b. Extension Brackets
 - c. Hold Down Brackets
 - d. Multi-Colored Stripping
 - e. Multiple Blinds on One Headrail
 - f. Pivot Plates
 - g. Projection Brackets
 - h. Restrictive Cam Tilter
 - i. Ring Pull
 - j. Telescopic or Non-Telescopic Pole
 - k. Top Lok Cord Lock
 - l. Universal Ring Tilter
 - m. 2 Slat Framed Vogue Valance
 - n. LightMaster™
 - o. Specialty Shapes

LEVOLOR

1400 Lavon Dr., McKinney, TX 75069 USA
 Phone: 1.800.826.8021 · LEVOLOR.com/commercial
 ©2018 LEVOLOR®. All rights reserved. US and non-US patents and patents pending.
 Product specifications are subject to change without notice. Printed in USA.